

A-A
1:3

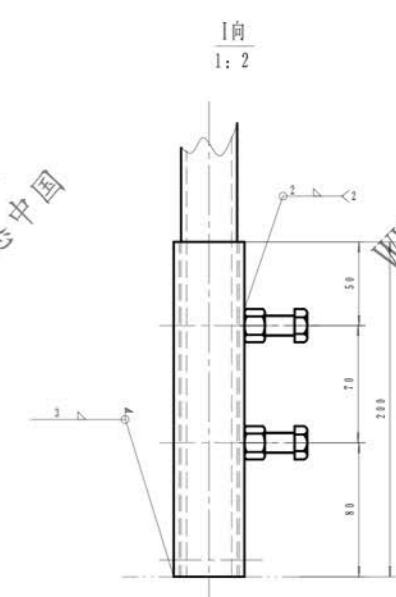

C-C
1:3

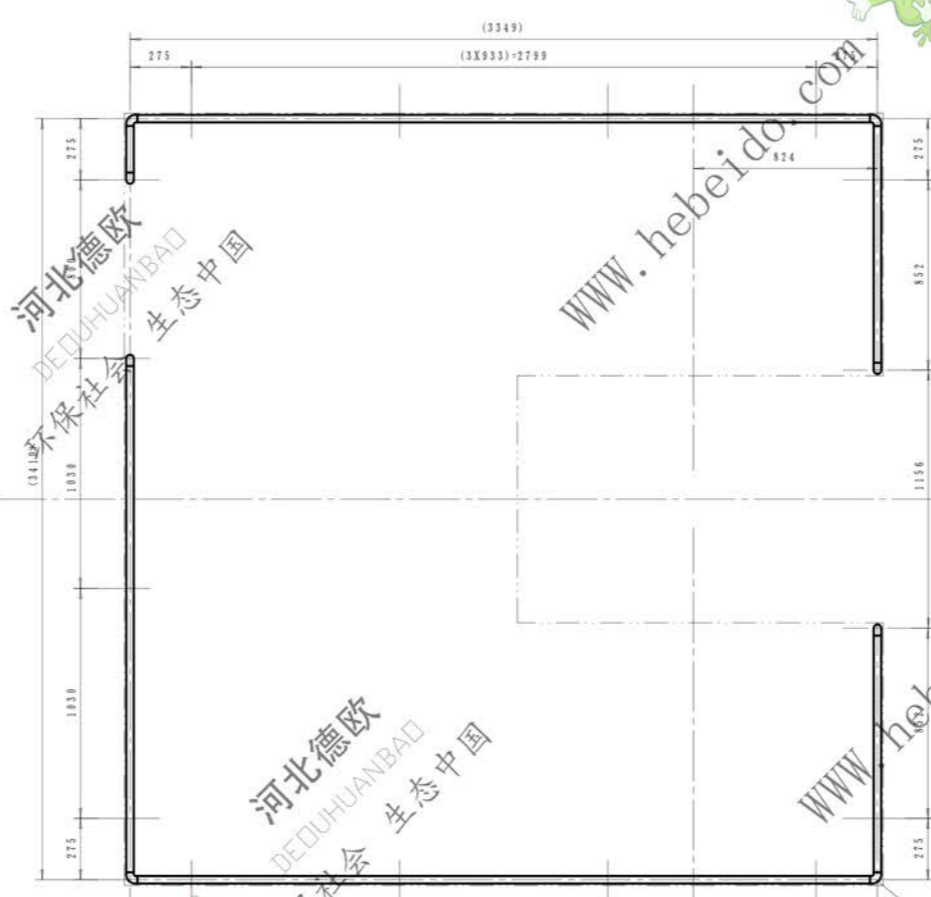
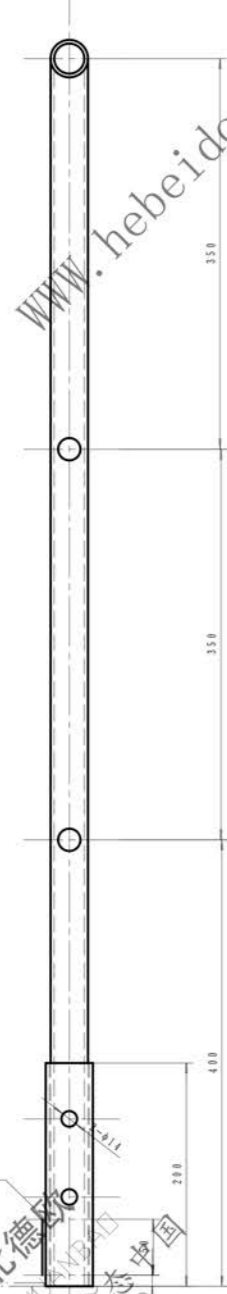
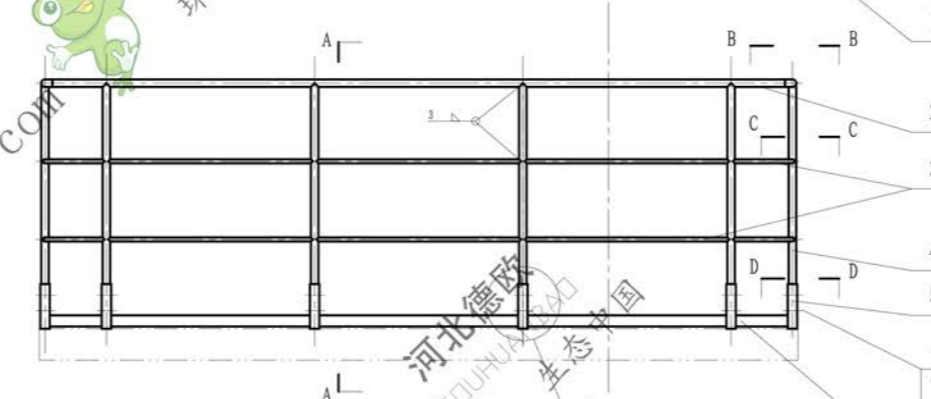
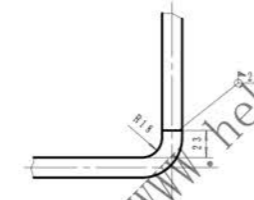

D-D
1:1



I向
1:2

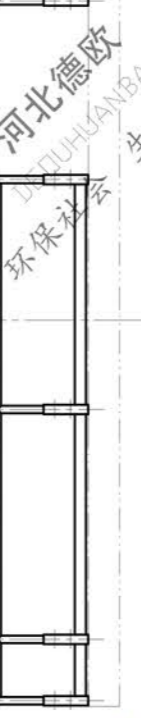

B-B
1:3

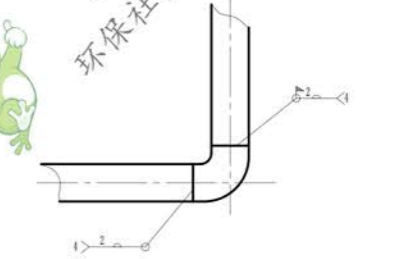

| 件号 | 图号 | 名称 | 数量 | 材料 | 单重 kg | 总重 kg | 备注 |
|----|-----------|-------------|----|-------|----------|----------|----------|
| 8 | | 栏杆Φ3 | | Q235A | 13.25 | 13.25 | L=11.66m |
| 7 | GB41-86 | 螺母M12 | 32 | Q235A | 0.016 | 0.512 | |
| 6 | GB5780-86 | 螺栓M12X30 | 32 | Q235A | 0.027 | 0.864 | |
| 5 | YB234-63 | Φ25(1")钢管 | 16 | Q235A | 0.73 | 11.27 | |
| 4 | YB234-63 | Φ25(1")钢管 | 16 | Q235A | 2.66 | 42.56 | |
| 3 | | 圆钢Φ18 | | Q235A | 46.14 | 46.14 | L=23.12m |
| 2 | YB234-63 | Φ25(1")钢管 | | Q235A | 27.96 | 27.96 | L=11.56m |
| 1 | | Φ32(1.5")弯头 | | Q235A | 0.2 | 1.6 | |

| 设计 | | | | 审核 | | 日期 | | 比例 | | 备注 | |
|-----|-----|----|----|----|-----|-----|-----|-----|-----|-----|-----|
| 设计 | 李连城 | 审核 | 姜海 | 日期 | 1:1 | 1:1 | 1:1 | 1:1 | 1:1 | 1:1 | 1:1 |
| 制图 | | 工艺 | | | | | | | | | |
| 文件名 | | 共张 | | | | | | | | | |

结构件
栏杆
德政环保
环保社会 生态中国
NSE300-01-300